

Form 19086
(537)
Printed in U. S. A.

LIST OF PARTS



MACHINE No. 175-43

THE SINGER MANUFACTURING COMPANY

From the library of: Diamond Needle Corp

INSTRUCTIONS FOR OILING

Remove the two knurled thumb nuts and remove the large arm side cover from the front side of the machine.

Apply oil at all oil holes and at all points where parts are in movable contact at the top as well as inside the arm.

Replace the large arm side cover and tighten the two thumb nuts.

Lay the machine on its rear side and apply oil to all oiling points in the machine bed.

Turn down the hinged cover beneath the looper and apply oil to the cam on the looper shaft, then close the hinged cover.

Use only Singer "Manufacturing Sewing Machine Oil (Cloth and Leather)" for general use, or "Manufacturing Sewing Machine Oil (Stainless for White Goods)" where a stainless oil is desired.

Copyright, U. S. A., 1935, 1936 and 1937
by The Singer Manufacturing Co.
All Rights Reserved for all Countries

INDEX

	Page
Accessories.....	15
Belt and Pulley Guard.....	16
Machine Base.....	15
Machine No. 175-43.....	5
Starting Lever and Foot Lifter Parts.....	16
Table Belt Guide.....	17
Thread Unwinder.....	17

From the library of: Diamond Needle Corp

1935-1937

INSTRUCTIONS FOR ORDERING

In ordering from this list, use ONLY the part NUMBER in the FIRST column.

The number stamped on a Sewing Machine Part is in every case the number of the single part only.

Every combination of parts sent out as such has its specific number, which, although not stamped on the parts, must be used when ordering the combination.

Each number always indicates the SAME PART in whatever list it appears, or for whatever machine.

The letters after some of the numbers indicate the style of finish only, as follows:

- A-Hardened, Polished, Nickel Plated and Buffed
- B-Polished, Nickel Plated and Buffed
- C-Hardened Only
- D-Polished Only
- E-Soft, Not Polished
- F-Hardened and Polished
- F.J-Hardened, Polished and Nickel Plated
- G-Bright Rumbled and Nickel Plated
- H-Blued
- J-Nickel Plated Only
- K-Hardened and Nickel Plated
- L-Brass Plated
- M-Oxidized
- N-Japanned, Dull
- P-Japanned, Bright
- R-Merlized
- S-Cadmium Plating
- T-Copper Plated
- T.A-Hardened, Polished, Copper and Nickel Plated and Buffed
- T.B-Copper and Nickel Plated and Polished
- T.J-Copper and Nickel Plated Only
- T.K-Hardened, Copper and Nickel Plated
- T.M-Copper Plated and Oxidized
- T.L-Copper and Brass Plated
- U-Zinc Plated
- V-Silver Plated
- W-Polished and Nickel Plated
- Y-Black Nickel Plated Only
- Z-Chromium Plated
- Z.B-Polished, Nickel Plated, Buffed and Chromium Plated
- Z.J-Nickel and Chromium Plated

These letters MUST BE USED when they appear in the list; and AFTER the number as in the list.

In this series:

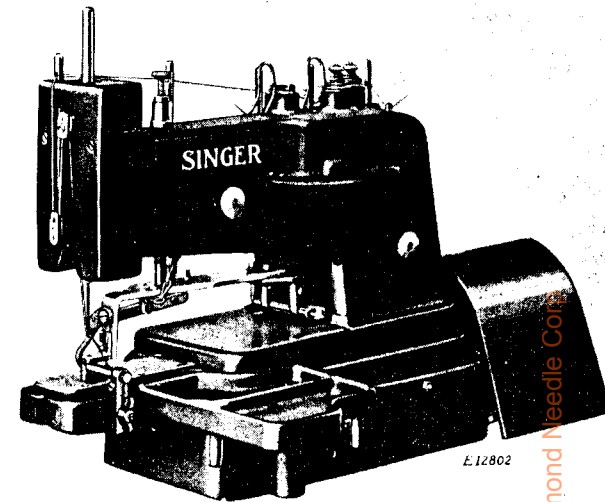
1 to 1500, 50001 to 51500 and 140001 to 142000 are Screw Numbers
 1501 to 1800 and 51501 to 51800 are Nut Numbers
 1801 to 2000 and 51801 to 52000 are Roller Numbers
 2001 to 50000 and 52001 to 140000 and 142001 to 190000 are Sewing Machine Parts, 190001 and upward are numbers of Electrical Parts.

The figures in the second column refer only to the plates, illustrating the parts, and are NOT TO BE USED in ordering.

Parts marked with an asterisk (*) are furnished only when they are made at factory.

LIST OF PARTS COMPLETE

FOR



MACHINE No. 175-43

For Sewing Self-Shank Buttons on Shirts, Sweaters, Children's Knit Goods, Sportwear, Etc. For metal, pearl, bone or composition self-shank buttons. Makes twelve stitches, including knotting stitch. Has needle bar vibration. Needle bar stroke $1 \frac{7}{8}$ inches. Button clamp for buttons from 14 to 28 ligne, fitted with special opening foot to conform with shape of button, and work support block for blind stitching only. Fitted with thread breaker or clamp, automatic and constant tensions and thread positioning finger. The thread is broken at the completion of the operation by raising the button clamp. Speed 1000 R. P. M.

No.	Plate	Name
*175001	-----	Arm with 15404 and two 15405.....
175002	21901	" Dowel Pin.....
*175003	-----	" Rock Shaft.....
175340	21935	" " " 175003 with 175007 and 175341.....

No.	Plate	Name
175005	21901	Arm Rock Shaft Crank (back) with 1177E, 1521J and 140016E.....
1177E	21901	Arm Rock Shaft Crank (back) Clamping Screw.....
140016E	21901	Arm Rock Shaft Crank (back) Position Screw.....
1521J	21901	Arm Rock Shaft Crank (back) Position Screw Lock Nut.....
*175341	-----	Arm Rock Shaft Crank (front).....
175007	21901	" " " " " " Pin.....
140017E	21901	" Screw (long).....
670E	21901	" " (short).....
175008	21901	" Side Cover (left).....
230J	21901	" " " " Screw.....
175009	-----	" " " (right).....
175010	21934	" " " " Screw Stud (long).....
175011	21934	" " " " " " (short).....
51649E	21901	" " " " " " Lock Nut.....
51650B	21901	" " " " " " Thumb Nut.....
*175386	-----	Bed.....
175013	21935	" End Cover (bottom).....
175751	-----	" " " " 175013 with 175016.....
175014	21901	" " " " Hinge Pin (left).....
175015	21901	" " " " " " (right).....
175016	21901	" " " " Spring.....
175017	21934	" " " " " Hook.....
175361	21935	" Top Cover (back) with two 175593.....
175593	21934	" " " " Oil Tube (brass).....
140016W	21934	" " " " Screw.....
175020	21934	" " " (front).....
140019F	21934	" " " " Screw.....
175387	21934	" Work Support.....
175388	-----	" " " 175387 with 175389 (adjustable).....
175389	21934	Bed Work Support Holder with 140061J....
140061J	21934	" " " " Clamping Screw..
140066J	21934	" " " " Guide Screw.....
51656J	21930	" " " " Lock Nut.....
175390	21936	" " " " " " Screw Stud.....
175032	21936	Bed Work Support Holder Lock Nut Washer.....
175378	21936	" " " " Stud.....
175362	21935	Button Clamp Arm.....
175363	21935	" " " " Hinge Bracket.....
175034	21935	" " " " " Pin.....
175035	21935	" " " " " Bracket.....
160J	21936	" " " " " " Screw.....
175036	21935	" " " " " " Shim (.003 in. thick).....

No.	Plate	Name
175037	-----	Button Clamp Arm Hinge Pin Bracket Shim (.005 in. thick).....
175038	-----	Button Clamp Arm Hinge Pin Bracket Shim (.007 in. thick).....
175039	-----	Button Clamp Arm Hinge Pin Bracket Shim (.015 in. thick).....
140072C	21936	Button Clamp Arm Screw.....
175032	21936	" " " " Washer.....
175041	21936	" " Lifting Arm with 190J, 190K and 1259C.....
1259C	21936	Button Clamp Lifting Arm Set Screw.....
175364	21935	" " " " Chain, 3 7/8 in. long.....
203K	21936	" " " " " Screw (lower).....
190K	21936	" " " " " " (upper).....
190J	21936	" " " " " " " Lock Screw.....
175043	21939	Button Clamp Lifting and Thread Pull-off Holder Shaft.....
175044	21936	Button Clamp Lifting and Thread Pull-off Holder Shaft Collar with 458C.....
458C	21936	Button Clamp Lifting and Thread Pull-off Holder Shaft Collar Set Screw.....
175045	21936	Button Clamp Lifting and Thread Pull-off Holder Shaft Spring.....
175046	21936	Button Clamp Lifting and Thread Pull-off Holder Shaft Spring Collar with 458C.....
458C	21936	Button Clamp Lifting and Thread Pull-off Holder Shaft Spring Collar Set Screw.....
175047	21939	Button Clamp Lifting Rod.....
175048	21939	" " " " " Arm with 160E and 50269C.....
160E	21936	Button Clamp Lifting Rod Arm Clamping Screw.....
50269C	21936	Button Clamp Lifting Rod Arm Position Screw.....
175049	21936	Button Clamp Lifting Rod Arm Stop Plate.....
160J	21936	" " " " " " " Screw.....
175032	21936	Button Clamp Lifting Rod Arm Stop Plate Screw Washer.....
42630	21936	Button Clamp Lifting Rod Cotter Pin.....
175050	21939	" " " " " Spring.....
175051	21936	" " " " " " Stop Collar with 160C.....
160C	21936	Button Clamp Lifting Rod Spring Stop Collar Set Screw.....
175365	21939	Button Clamp Presser Bar.....
175053	21936	" " " " " Collar with 458C.....
458C	21936	" " " " " " Set Screw.....

No.	Plate	Name
175054	21937	Button Clamp Presser Bar Screw Bearing..
175055	21939	" " " " Spring.....
140023W	21937	" " Pressure Regulating Thumb Screw.....
1722J	21937	Button Clamp Pressure Regulating Thumb Screw Lock Nut.....
175391	21937	Button Finger.....
140085K	21937	" " Hinge Screw.....
175387	21937	" " Lever.....
140084C	21937	" " " Adjusting Screw....
1735J	21937	" " " " " Nut.
140065K	21937	" " " Hinge Screw.....
175388	21937	" " " " " Bracket with 175024.....
1492J	21937	Button Finger Lever Hinge Screw Bracket Screw.....
175024	21937	Button Finger Lever Hinge Screw Bracket Steady Pin.....
175369	21937	Button Finger Lever Screw Eye.....
175370	21937	" " " " " Bushing...
175207	21930	" " " " " " " Spring.....
190J	21936	Button Finger Lever Screw Eye Screw....
1735J	21937	" " " " " " " Nut
175392	21937	" " Holder, 7/32 in. hole.....
175393	21937	" " " 5/16 in. hole.....
190J	21936	" " " Screw.....
175394	-----	Button Clamp complete, Nos. 1492J, 140085K 175207, 175362, 175363, 175367 to 175370, 175391 to 175393 and two each 190J, 1735J, 140064C, 140065K, 140072C and 175032.....
175060	21939	Face Plate.....
175061	-----	" " 175060 with 185J, 175062, 175063 175065, 175066 and 202098.....
120J	21938	Face Plate Screw.....
175062	21938	" " Thread Guide (lower) Plate...
185J	21938	" " " " " " " Screw.....
175063	21938	Face Plate Thread Guide (lower) Plate Screw Spacing Collar.....
202098	21938	Face Plate Thread Guide (lower) Roller..
175065	21938	" " " " " " " Pin
175066	21938	" " " " " (upper).....
175085	21938	Looper.....
175086	21939	" Driving Shaft.....
175087	21939	" " " Bushing.....
175594	-----	" " " " 175087 with 175086, 175091 and 175092.....

No.	Plate	Name
51183E	21938	Looper Driving Shaft Bushing Clamping Screw.....
*175088	-----	Looper Driving Shaft Crank with 435C and 1285C.....
175525	21938	Looper Driving Shaft Crank 175088 with 175090.....
175089	21938	Looper Driving Shaft Crank Connecting Link.....
175659	-----	Looper Driving Shaft Crank Connecting Link 175089 with 175525 and 175526..
*175090	-----	Looper Driving Shaft Crank Connecting Link Hinge Stud.....
1285C	21938	Looper Driving Shaft Crank Position Screw.....
435C	21938	Looper Driving Shaft Crank Set Screw....
175091	21938	" " " " Gear.....
175092	21938	" " " " " Pin.....
458C	21936	" Set Screw.....
175093	21939	" Shaft with 458C.....
*175095	-----	" " Crank with two 140027C....
175528	21938	" " " 175095 with 175133...
140027C	21938	" " " Set Screw.....
*175133	-----	" " " Stud.....
175096	21938	Machine Rest Stud.....
458C	21936	" " " Set Screw.....
175396	21939	Needle Bar (hollow) with 200125F.....
175348	21940	" " " Connecting Link.....
140028C	21940	" " " " Hinge Screw..
1722J	21937	" " " " " " " Nut
175099	21940	" " " " " " " Stud with 160E.....
175629	-----	Needle Bar Connecting Link Hinge Stud 175099 with 1492J, 175100 and 175101.
160E	21936	Needle Bar Connecting Link Hinge Stud Clamping Screw.....
175100	21940	Needle Bar Connecting Link Hinge Stud Thread Guide Plate.....
1492J	21937	Needle Bar Connecting Link Hinge Stud Thread Guide Plate Screw.....
175101	21940	Needle Bar Connecting Link Hinge Stud Thread Guide Roller.....
175349	21940	Needle Bar Connecting Stud (lower).....
1681J	21940	" " " " " " " Nut....
51652J	21940	" " " " " " " Lock Nut.....
175103	21940	Needle Bar Connecting Stud (lower) Wash- er.....
175104	21940	Needle Bar Connecting Stud (upper).....
1681J	21940	" " " " " " " Nut..

No.	Plate	Name
51652J	21940	Needle Bar Connecting Stud (upper) Nut Lock Nut.....
175103	21940	Needle Bar Connecting Stud (upper) Wash- er.....
175105	21943	Needle Bar Eccentric with 140027C.....
175106	21919	" " " Connecting Rod with 1521J,140024E,175535 and two 140029E
140029E	21940	Needle Bar Eccentric Connecting Rod Cap Screw.....
140024E	21940	Needle Bar Eccentric Connecting Rod Clamping Screw.....
1521J	21901	Needle Bar Eccentric Connecting Rod Clamping Screw Nut.....
140031C	21940	Needle Bar Eccentric Connecting Rod Hinge Screw.....
51653E	21940	Needle Bar Eccentric Connecting Rod Hinge Screw Nut.....
175535	21940	Needle Bar Eccentric Connecting Rod Oil Pad (felt).....
175108	21940	Needle Bar Eccentric Pawl with 175114...
175109	-----	Needle Bar Eccentric Pawl complete, Nos. 175108,175110 and 175112.....
175110	21940	Needle Bar Eccentric Pawl Bracket with 175111.....
134E	21940	Needle Bar Eccentric Pawl Bracket Screw.
175111	21940	" " " " " Steady Pin.....
175112	21942	Needle Bar Eccentric Pawl Hinge Pin....
175113	21942	" " " " Spring.....
175114	21942	" " " " Stud...
175119	21942	" " " Pin.....
140027C	21938	" " " Set Screw.....
175118	21943	" " Vibrating Cam with 175185....
175068	21943	" " " " Driving Worm...
175069	21942	" " " " " Pin
175070	21943	" " " " " "
140026C	21942	Wheel with 175229 and two 140026C... Needle Bar Vibrating Cam Driving Worm Wheel Set Screw.....
175374	21943	Needle Bar Vibrating Cam Driving Worm Wheel Shaft.....
175608	-----	Needle Bar Vibrating Cam Driving Worm Wheel Shaft 175374 with 175118 and 175119.....
175119	21942	Needle Bar Vibrating Cam Pin.....
175120	21919	" " " Lever.....
175756	21942	" " " " Adjusting Bracket with 458C and 1341C.....

No.	Plate	Name
175759	-----	Needle Bar Vibrating Lever Adjusting Bracket 175756 with 175123,175757 and 175758.....
175757	21942	Needle Bar Vibrating Lever Adjusting Bracket Hinge Stud.....
1341C	21942	Needle Bar Vibrating Lever Adjusting Bracket Hinge Stud Set Screw.....
175758	21941	Needle Bar Vibrating Lever Adjusting Bracket Hinge Stud Slide.....
51654C	21941	Needle Bar Vibrating Lever Adjusting Bracket Lock Nut.....
175123	21941	Needle Bar Vibrating Lever Adjusting Bracket Lock Nut Screw Stud.....
458C	21936	Needle Bar Vibrating Lever Adjusting Bracket Lock Nut Screw Stud Set Screw.....
175125	21941	Needle Bar Vibrating Lever Adjusting Bracket Lock Nut Washer.....
175126	21919	Needle Bar Vibrating Lever Arm with 51923.....
140033C	21922	Needle Bar Vibrating Lever Arm Hinge Screw.....
51923	21942	Needle Bar Vibrating Lever Arm Roller and Screw Stud.....
140024E	21940	Needle Bar Vibrating Lever Arm Screw....
175032	21936	" " " " " Wash- er.....
140034C	21941	Needle Bar Vibrating Lever Hinge Screw..
140035C	21941	" " " " " "
175127	21941	Lock Screw.....
175127	21941	Needle Bar Vibrating Lever Hinge Screw Slide.....
*175421	-----	Needle Guide.....
175591	-----	" " 175421 with 175547 and two 218D.....
175546	21943	Needle Guide 175591 with 175131 and 175136.....
175130	21941	Needle Guide Cam with two 1259C.....
1259C	21936	" " " Set Screw.....
175131	21941	" " Pin.....
175132	21941	" " Oscillating Crank with 140159E and 175134.....
140159E	21941	Needle Guide Oscillating Crank Clamping Screw.....
175016	21901	Needle Guide Oscillating Crank Spring...
175134	21941	" " " " " Hook (crank end).....
175135	21941	Needle Guide Oscillating Crank Spring Hook (bed end).....

No.	Plate	Name
175136	-----	Needle Guide Shaft.....
175094	21941	" " " Bushing.....
458C	21936	" " " " Set Screw.....
175547	21941	" " " Thread Finger.....
218D	21941	" " " " Screw.....
175375	21943	" .Plate with two 175378.....
140019F	21934	" " " Screw.....
200125F	21942	" " " Set Screw.....
175379	21942	Plug, for Feed Plate Carrier Regulator Shaft Hole.....
*175139	-----	Pulley.....
175140	21919	" 175139, 2 3/4 in. diam., with 51655J, 140037C, 175141 and 175147....
Note: No. 175140 is regularly furnished with this machine unless otherwise specified on order.		
*175633	-----	Pulley.....
175634	-----	" 175633, 3 1/4 in. diam., with 51655J, 140037C, 175141 and 175147....
*175635	-----	Pulley.....
175636	-----	" 175635, 3 3/4 in. diam., with 51655J, 140037C, 175141 and 175147....
140037C	21921	Pulley Engaging Screw.....
51655J	21921	" " " Nut.....
175141	21921	" Oil Pad (wick).....
175142	21919	" Shaft.....
175596	-----	" " 175142 with 175068, 175069, 175105, 175143, 175144, 175150 and two 175119.....
175143	21942	Pulley Shaft Gear.....
175144	21942	" " " Pin.....
175145	21921	" Shifter.....
175146	21919	" " Holder with 51649J and 140078C.....
140078C	21921	Pulley Shifter Holder Set Screw.....
51649J	21901	" " " " Lock Nut.
*175147	-----	" " " Ring (V grooved).....
1178E	21921	" " " Screw.....
175148	21919	Starting Crank with 1747J and 140039E...
175630	-----	" " 175148 with 175149 and 175155.....
140039E	21921	Starting Crank Adjusting Screw.....
1747J	21921	" " " " Nut.....
175149	21921	" " " Pin.....
175150	21942	Stop Dog.....
175151	21921	" " " Cushion Spring.....
175152	21943	" " " " Holder with 50581C 175151 and two 140040C.....
50581C	21921	Stop Dog Cushion Spring Holder Set Screw
140040C	21921	" " " " Set Screw.....

No.	Plate	Name
175119	21942	Stop Dog Pin.....
175153	21921	" Motion Retaining Collar.....
160J	21936	" " " " Screw.....
175154	21921	" " " " Stud.
882C	21921	" " " " " Set Screw.....
175155	21943	Stop Motion Shaft.....
175156	21944	" " " " Spring.....
175157	21944	" " " " Collar with 140041C.....
140041C	21921	Stop Motion Shaft Spring Collar Set Screw.....
175158	21944	Stop Motion Trip.....
175159	21944	" " " Block with 882C with 175154.....
140042C	21941	Stop Motion Trip Block Hinge Screw.....
51649E	21901	" " " " " Nut..
175113	21942	" " " " Spring.....
175229	21921	" " " Point.....
160J	21936	" " " Screw.....
175032	21936	" " " " Washer.....
175160	21922	Tension (automatic) Disc.....
175161	21922	" " " Position Pin...
1560C	21922	" " " Regulating Thumb Nut
175162	21922	" " " Releasing Cam with two 140027C.....
140027C	21938	Tension (automatic) Releasing Cam Set Screw.....
175522	21922	Tension (automatic) Releasing Disc.....
175163	21943	" " " " Rod.....
1521J	21901	" " " " Adjust- ing Nut.....
1521J	21901	Tension (automatic) Releasing Rod Ad- justing Nut Lock Nut.....
175164	21943	Tension (automatic) Releasing Rod Spring
175165	21922	" " " " Wear- ing Sleeve.....
140043C	21922	Tension (automatic) Screw Stud.....
175166	-----	" " " " 140043C with 1560C.....
125314	21922	Tension (automatic) Spring.....
175167	21922	" " " Thread Eyelet.....
175168	-----	Tension (automatic) complete, Nos. 125314 175166, 175522 and two 175160.....
175160	21922	Tension (stationary) Disc.....
175161	21922	" " " Position Pin..
1560C	21922	" " " Regulating Thumb Nut.....
140044C	21922	Tension (stationary) Screw Stud.....

From the Library of the Sewing Machine Museum

PARTS FOR MACHINE No. 175-43

No.	Plate	Name
175169	-----	Tension (stationary) Screw Stud 140044C with 1560C.....
13710	21922	Tension (stationary) Spring.....
175170	-----	Tension (stationary) complete, Nos.13710 175169 and two 175160.....
175171	21922	Thread Eyelet (back).....
175172	21922	" " (front).....
175173	21944	" Nipper Head.....
175174	21944	" " Plate.....
180J	21936	" " " Screw.....
175175	21944	" " " Washer.....
140045K	21944	" " Releasing Head Screw.....
175178	21943	" " " Lever.....
140046C	21944	" " " Hinge Screw
175177	21944	" " " Rod.....
175178	-----	" " " " 175177 with 175173.....
175179	21944	Thread Nipper Releasing Rod Spring (lower).....
175180	21944	Thread Nipper Releasing Rod Spring (lower) Washer.....
175181	21944	Thread Nipper Releasing Rod Spring (upper).....
175182	21944	Thread Nipper Releasing Rod Spring Collar with 465C.....
465C	21944	Thread Nipper Releasing Rod Spring Collar Set Screw.....
175183	21944	Thread Nipper Releasing Screw Stud.....
1722J	21937	" " " " " Nut..
175184	21944	" " " " " Washer.....
175185	21945	Thread Nipper Releasing Stud.....
175181	21922	" " Thread Guide Pin.....
175186	21945	" Pull-off (back).....
175187	21945	" " " Holder with 160C and 1120C.....
160C	21936	Thread Pull-off (back) Holder Set Screw.
1120C	21945	" " " Set Screw.....
175188	21945	" " (front).....
175189	21945	" " " Holder with 1120C and 175190.....
175190	21945	Thread Pull-off (front) Holder Stop Pin.
1120C	21945	" " " Set Screw.....
175191	21945	" " Stop Collar with 160C and 175192.....
160C	21936	Thread Pull-off Stop Collar Set Screw...
175192	21945	" " " Stop Pin....
175187	21922	" " Thread Eyelet.....
*15404	-----	Trade Mark.....
15405	-----	" " Rivet.....

ACCESSORIES

No.	Plate	Name
175193	21946	Button Tray with three 175194.....
175194	21946	" " Hinge Screw Stud.....
180C	21936	" " " " Set Screw, for Machine Base.....
175195	21946	Hand Wheel with 1448C, for turning machine by hand.....
1448C	21945	Hand Wheel Set Screw.....
120342	21946	Oiler (copper plated) with 120343.....
120343	21946	" Spout, 3 1/2 in. long.....
26028	21946	Screw Driver.....
175197	21946	Wrench for 140026.....
175198	21946	" " 140027.....

MACHINE BASE

No.	Plate	Name
175199	-----	Machine Base with 175210.....
175200	21931	Machine Base complete, Nos. 145C,160C, 1837J,140047C,140048C,175032,175199, 175208 to 175210,175425 and four wood screws 7/8 in. No. 14 R.H.....
140047C	21930	Machine Locating Screw Stud.....
*175201	-----	" Lock Plate.....
175115	21930	" " " 175201 with 175202, 175205 and 175206.....
*175202	21930	Machine Lock Plate Position Stud.....
*175205	21930	" " Stud.....
51656J	21930	" " Thumb Nut.....
175206	21930	" " " Screw Stud.....
175207	21930	" " " Spring.....
175536	21930	" " " Washer.....
175425	-----	Machine Lock complete, Nos. 51656J,175115 175207 and 175536.....
175208	21930	Machine Starting Lever with 175424.....
140048C	21930	" " " Hinge Screw.....
175032	21936	" " " " Washer
175209	21930	" " " Spring.....
175210	21930	" " " " Hook (long)
175424	21930	" " " " " (short)
145C	21930	" " " Stop Screw.....
1837J	21930	" " " " Nut....

BELT AND PULLEY GUARD (HINGED)

No.	Plate	Name
175537	21932	Belt and Pulley Guard.....
175538	21932	" " " " Fill-in Piece (metal) with two wood screws 3/4 in. No. 10 R.H., for Trough Power Tables
175539	21932	Belt and Pulley Guard Fill-in Piece (wood) with four wood screws 1 1/2 in.No.12 F.H.,for Flat Power Tables.
175540	-----	Belt and Pulley Guard complete, for In- dividual Motor Tables and for 175544 Nos. 42830,175537,175543 and two wood screws 1 in. No. 14 F.H.....
175541	21932	Belt and Pulley Guard Hinge Pin.....
175542	21932	" " " " " " Bracket.
175543	21932	" " " " " " " "
		175542 with 175541.....
42830	21938	Belt and Pulley Guard Hinge Pin Cotter Pin.....
175544	-----	Belt and Pulley Guard with Fill-in Pieces complete, Nos. 175538 to 175540.....

STARTING LEVER AND FOOT LIFTER PARTS

No.	Plate	Name
175215	-----	Foot Lifter Chain,37 in.long,with two 58865.....
58865	21945	Foot Lifter Chain Hook.....
175216	21931	" " Treadle.....
175217	21931	" " " Hinge Pin.....
175218	21931	" " " Stand.....
175219	21931	Foot Lifter Treadle complete,Nos. 175216 to 175218 and two wood screws 1 in. No. 14 F.H.....
175215	-----	Starting Lever Chain, 37 in. long, with two 58865.....
58865	21945	Starting Lever Chain Hook.....
175216	21931	" " Treadle.....
175217	21931	" " " Hinge Pin.....
175218	21931	" " " Stand.....
175219	21931	Starting Lever Treadle complete, Nos. 175216 to 175218 and two wood screws 1 in. No. 14 F.H.....

TABLE BELT GUIDE

No.	Plate	Name
175220	21931	Belt Guide (left) with 140035C.....
175221	21931	" " (right) with 140035C.....
140035C	21941	" " Set Screw.....
175222	21931	Pulley.....
175223	-----	" Shaft.....
175224	21931	" " 175223 with 1259E and 175227
175225	21931	" " Bracket with 444C.....
1259E	21938	" " Oil Plug Screw.....
175227	21931	" " " Wick.....
444C	21945	" " Set Screw.....
175228	21931	Table Belt Guide complete, Nos. 175220, 175221,175224,175225 and two each 175222 and wood screws 7/8 in. No. 14 R.H.....

THREAD UNWINDER (FOR ONE SPOOL)

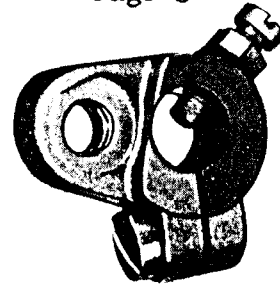
No.	Plate	Name
225259	21933	Spool Rest with 201018C.....
150203	21933	" " Cushion (felt).....
225388	21933	" " Rod.....
200383C	21945	" " Set Screw.....
201018C	21945	" " Set Screw.....
202490	21933	" Stand with 200383C.....
225391	21933	Thread Guide.....
201896J	21945	" " Lock Nut.....
225328	21945	" " Position Cup.....
225324	21933	" " Rod with 208E and 225322...
208E	21945	" " Screw.....
225322	21945	" " Washer.....
225280	21933	Thread Unwinder complete, Nos. 150203, 201896J,202490,225259,225324,225328, 225388,225391 and three wood screws 7/8 in. No. 12 F.H.....
27739	21933	Thread Cone (wood) for large cones.....
225390	21933	" " Holder, for inverted cones..

Note: Nos. 27739 and 225390 are used with, but not included in 225280.

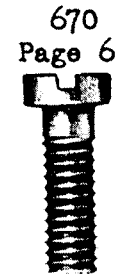
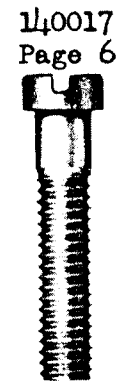
ILLUSTRATIONS
OF
PARTS

PLATE 21901 - FULL SIZE

175005
Page 6



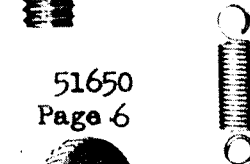
175008
Page 6



175016
Page 6

230
Page 6

1521
Page 6



51650
Page 6



51649
Page 6



175014
Page 6



175015
Page 6



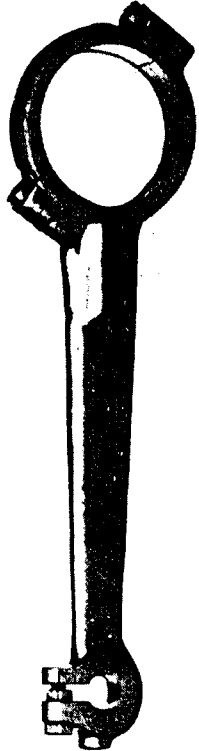
From the Illustrations of the Missile Body

PLATE 21919 - ONE-HALF SIZE

175120
Page 10



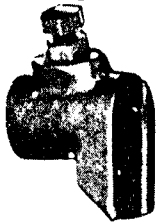
175106
Page 10



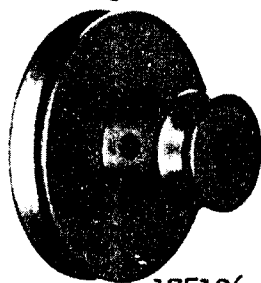
175142
Page 12



175146
Page 12



175140
Page 12



175148
Page 12

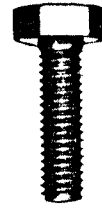


175126
Page 11

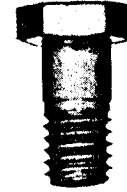


PLATE 21921 - FULL SIZE

140078
Page 12



140037
Page 12



175141 175149
Page 12 Page 12



175145
Page 12



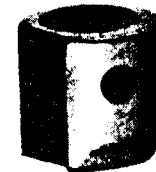
1178
Page 12



140039
Page 12



175153
Page 13



51655
Page 12



175151
Page 12



140041
Page 13



140040
Page 12



1747
Page 12



175229
Page 13



50581
Page 12



175154
Page 13

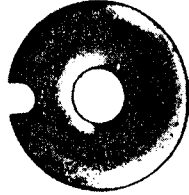


882
Page 13



PLATE 21922 - FULL SIZE

175160
Page 13



175522
Page 13



1560
Page 13



175161
Page 13



175165
Page 13



140033
Page 11



175171
Page 14



175167
Page 13



175172
Page 14



140043
Page 13



140044
Page 13



125314
Page 13



13710
Page 14



175162
Page 13

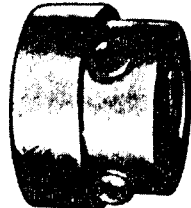


PLATE 21930 - FULL SIZE

175115
Page 15



175208
Page 15



175424
Page 15



140047
Page 15



140048
Page 15



175210
Page 15



175207
Page 8



175205
Page 15



51656
Page 6



175206
Page 15



175202
Page 15



175209
Page 15



175536
Page 15



1637
Page 15



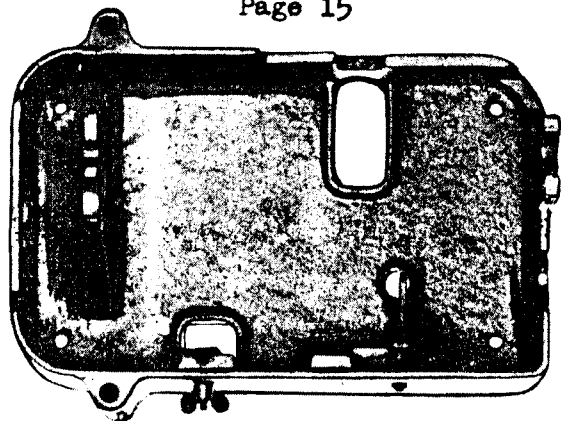
145
Page 15



From the Library of the National Needle Corporation

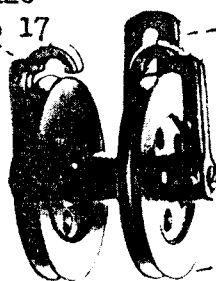
PLATE 21931 - ONE-FOURTH SIZE

175200
Page 15



175228
Page 17

175220
Page 17



175225
Page 17

175221
Page 17

175222
Page 17

175227
Page 17



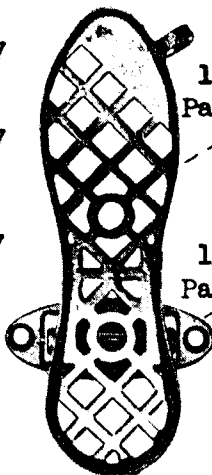
175224
Page 17



175219
Page 16

175216
Page 16

175218
Page 16

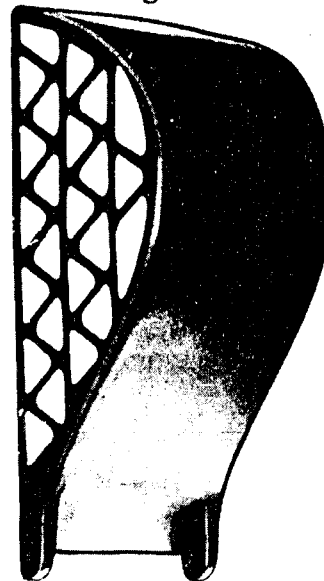


175217
Page 16

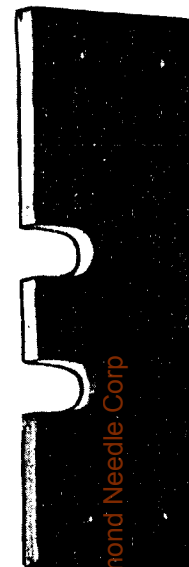


PLATE 21932 - ONE-FOURTH SIZE

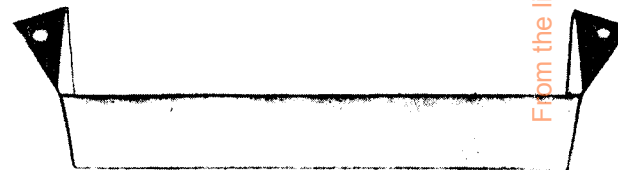
175537
Page 16



175539
Page 16



175538
Page 16



From the library of: Diamond Needle Corp

175543
Page 16



175542
Page 16

175541
Page 16

PLATE 21933 - ONE-FOURTH SIZE

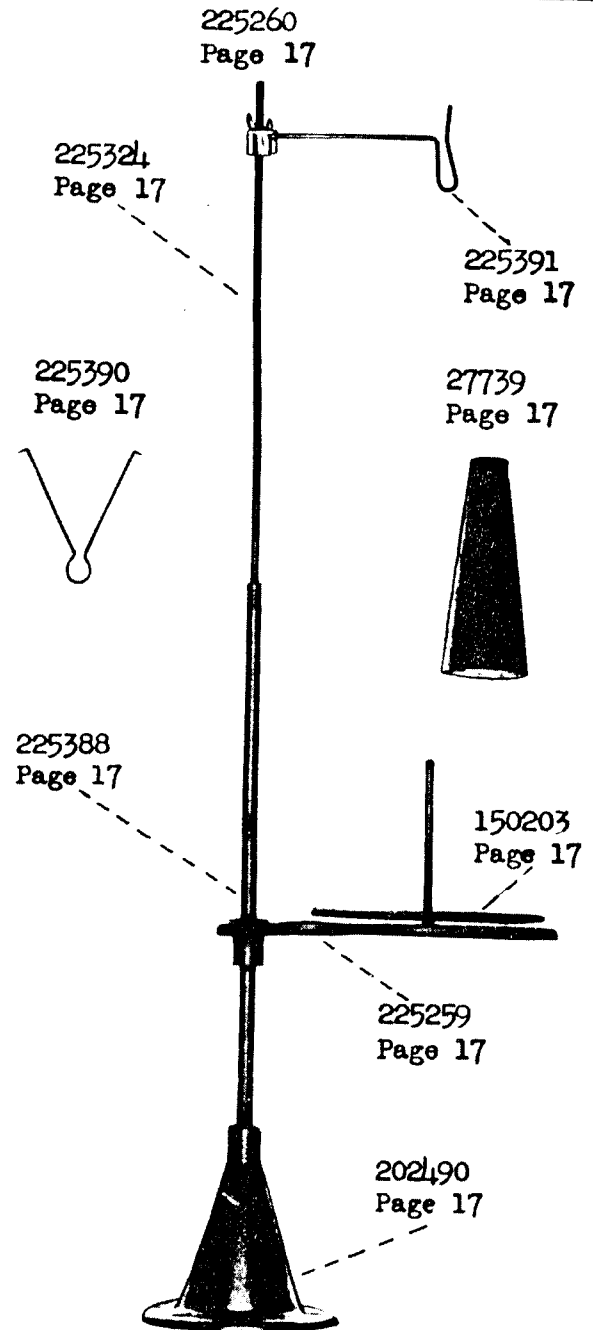


PLATE 21934 - FULL SIZE

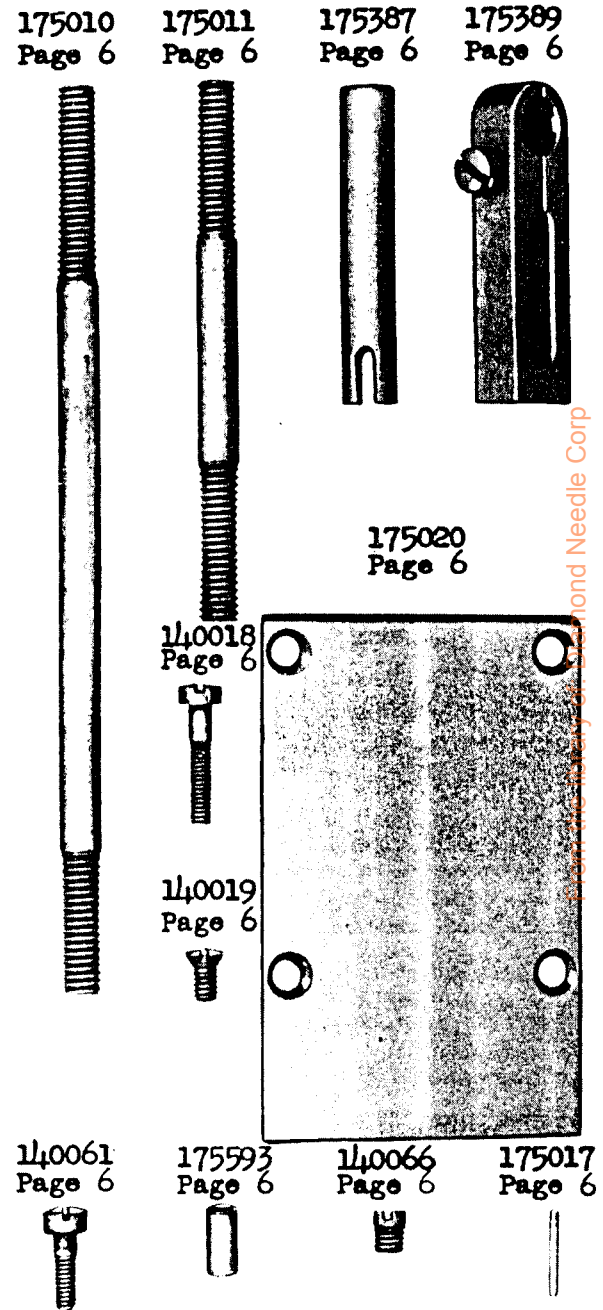
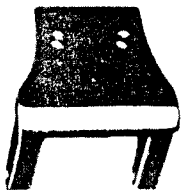


PLATE 21935 - ONE-HALF SIZE

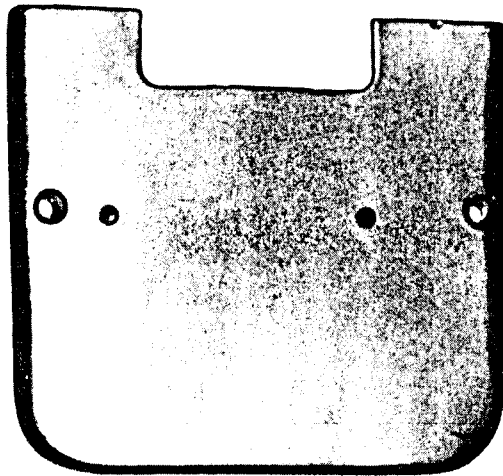
175340
Page 5



175363
Page 6



175361
Page 6



175013
Page 6



175362 175036 175035
Page 6 Page 6 Page 6



175364
Page 7



175034
Page 6



PLATE 21936 - FULL SIZE

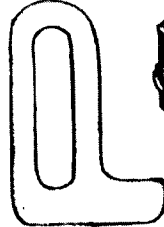
175045
Page 7



175390
Page 6



175049
Page 7



175032
Page 6



175041
Page 7



203
Page 7



160
Page 7



175046
Page 7



458
Page 7



175051
Page 7



175044
Page 7



190
Page 7



50269
Page 7



42830
Page 7



140072
Page 7



175053
Page 7



1259
Page 7



175378
Page 6



from the library of the National Archives

PLATE 21937 - FULL SIZE

175367
Page 8



175054
Page 8



140023
Page 8



175391
Page 8



175370
Page 8



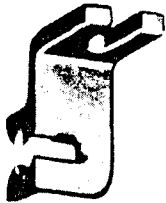
175024
Page 8



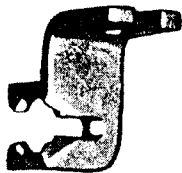
1735 Page 8



175392
Page 8



175393
Page 8



140064
Page 8



175368
Page 8



175369
Page 8



1492
Page 8



1722
Page 8



140085
Page 8

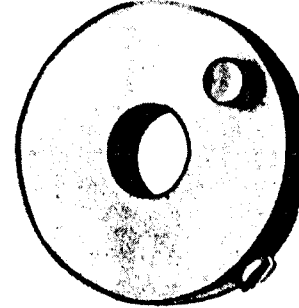


140065
Page 8

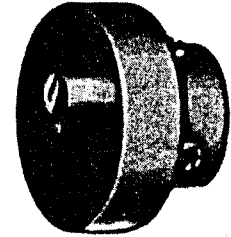


PLATE 21938 - FULL SIZE

175525
Page 9



175526
Page 9



120
Page 8



175096
Page 9



175066
Page 8



185
Page 8



175091
Page 9



175089
Page 9



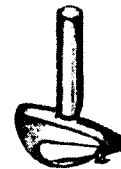
175062
Page 8



1285
Page 9



175085
Page 8



51183
Page 9



175092
Page 9



435
Page 9



140027 Page 9



175065 Page 8



202098
Page 8



175063
Page 8



From the original: Diamond Needle Co.

PLATE 21939 - ONE-HALF SIZE

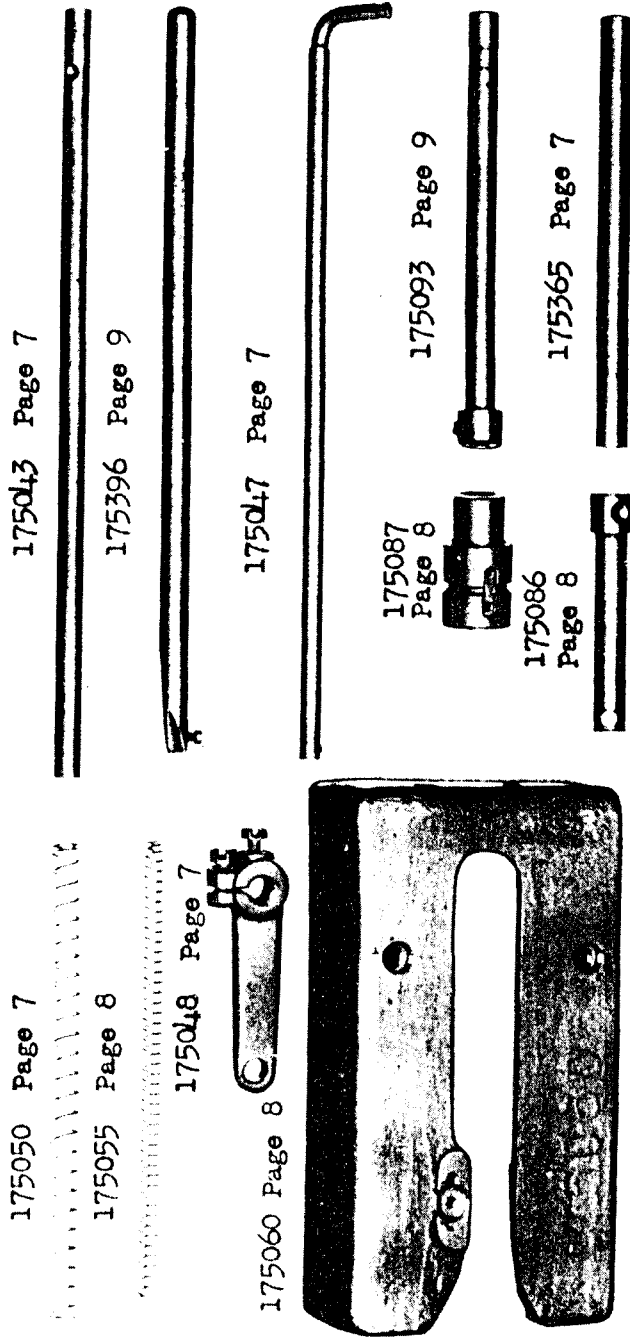


PLATE 21940 - FULL SIZE

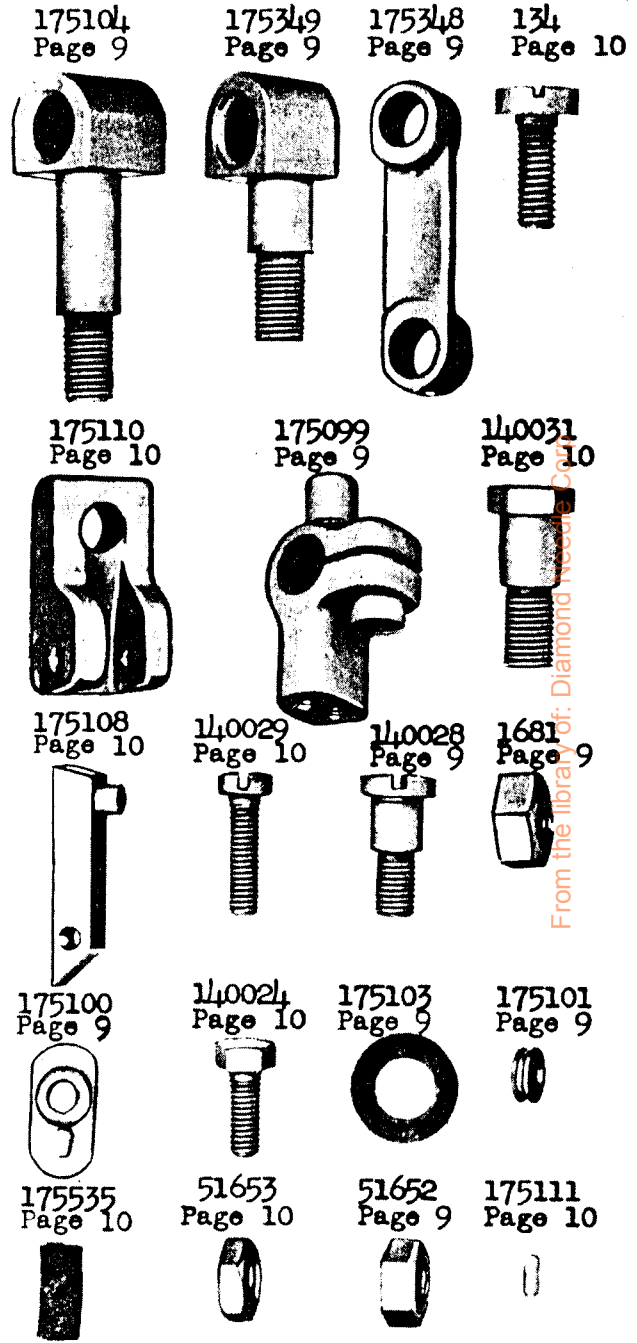


PLATE 21941 - FULL SIZE

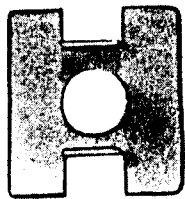
51654
Page 11



175758
Page 11



175125
Page 11



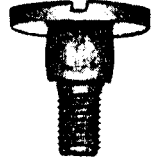
175123
Page 11



140042
Page 13



140034
Page 11



175127
Page 11



140035
Page 11



175131
Page 11



140159
Page 11



175132
Page 11



175134
Page 11



175135
Page 11



175094
Page 12



218
Page 12



175130
Page 11



175547
Page 12

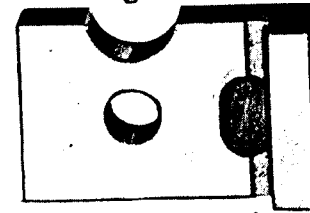


PLATE 21942 - FULL SIZE

175150
Page 12



175756
Page 10



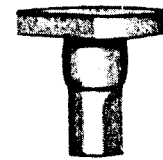
175114 Page 12 175114 Page 10



175379
Page 12



175757
Page 11



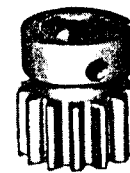
51923
Page 11



140026
Page 10



175143
Page 12



175119
Page 10



175069
Page 10



1341
Page 11



175113
Page 10



175112
Page 10



200125
Page 12



from the library of: www.egon.com

PLATE 21943 - ONE-HALF SIZE

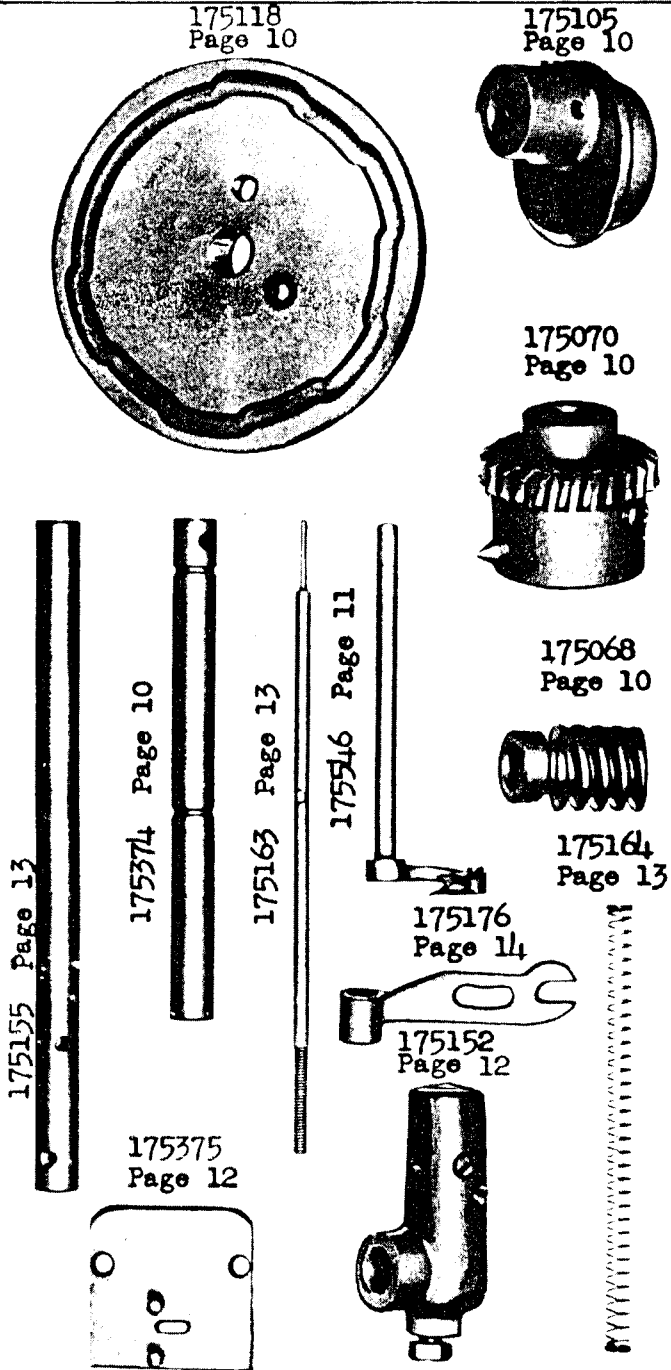


PLATE 21944 - FULL SIZE

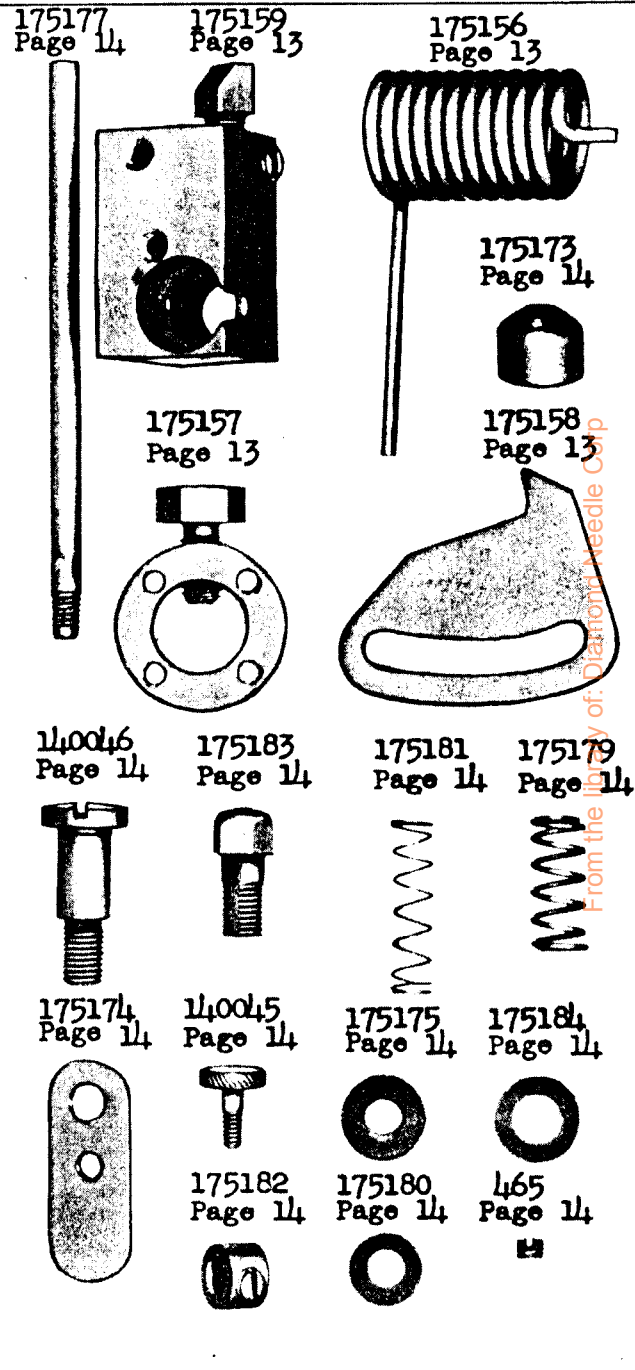
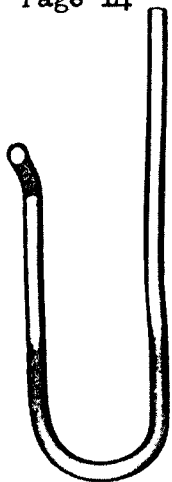


PLATE 21945 - FULL SIZE

175188
Page 14



56865
Page 16



201696
Page 17



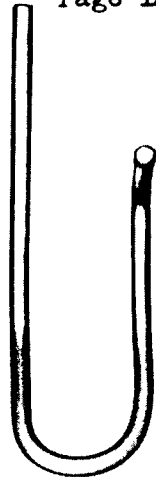
1120
Page 14



175185
Page 14



175186
Page 14



175192
Page 14



225322
Page 17



201018
Page 17



208
Page 17



175191
Page 14



175187
Page 14



175189
Page 14



225326
Page 17



444
Page 17



200383
Page 17



1448
Page 15



175190
Page 14



PLATE 21946 - ONE-HALF SIZE

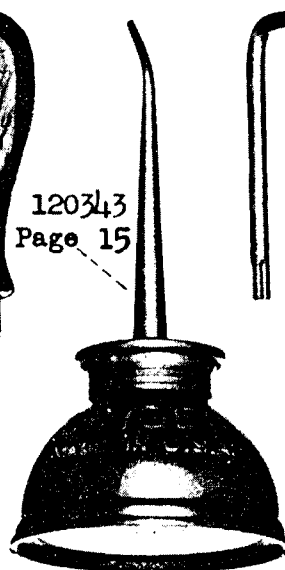
26026
Page 15



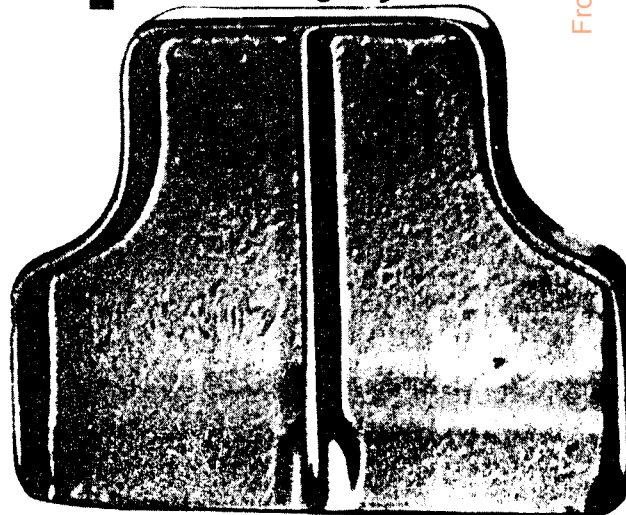
175194
Page 15



120342
Page 15



175193
Page 15



175197
Page 15



175195
Page 15



175198
Page 15



From the library of: Diamond Needle Co.